

GUS GEAR®

LOCK 2000 VEST INSTRUCTIONS:



BACK EXIT SITES

GET TO KNOW THE LOCK 2000 VEST

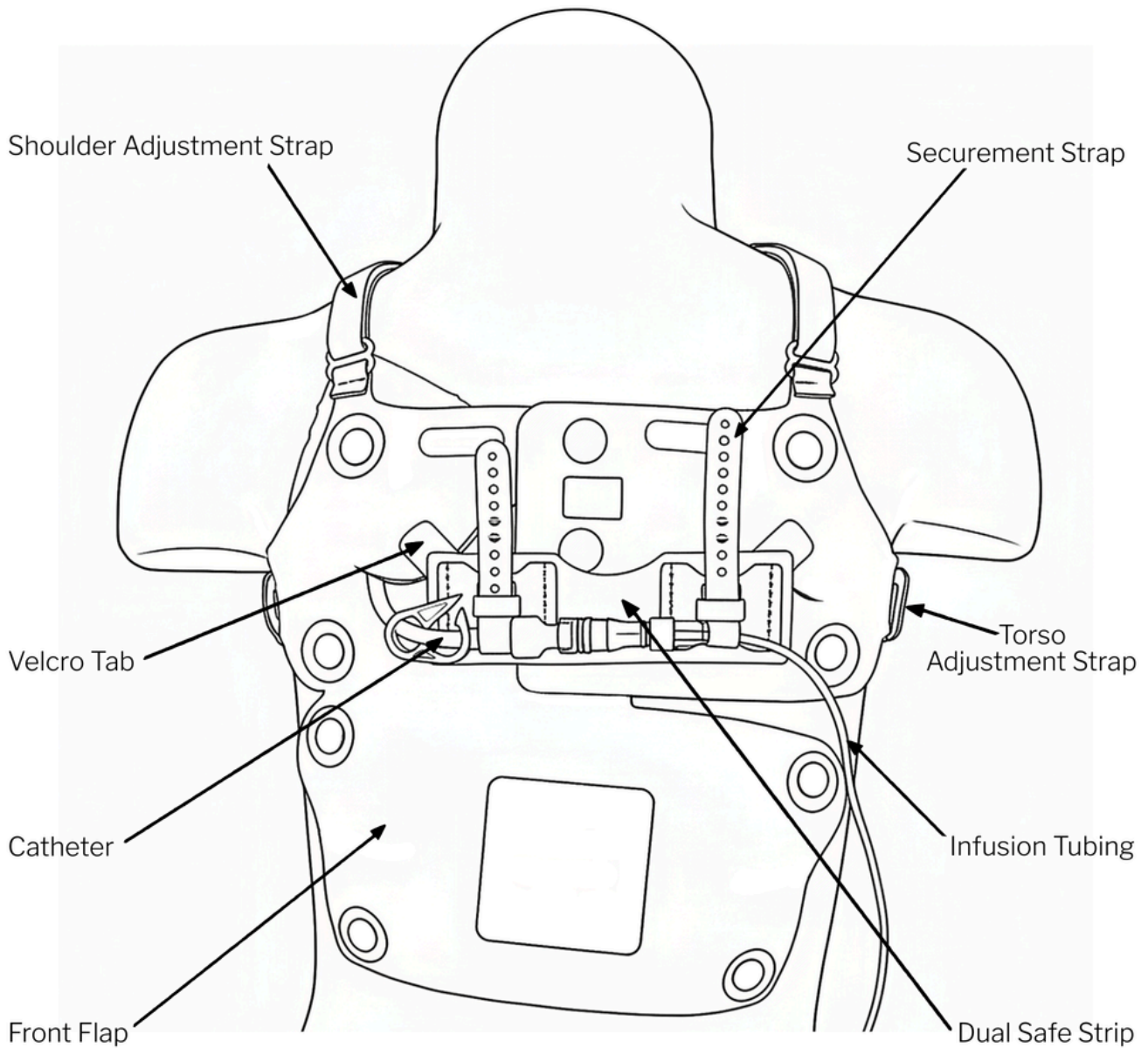
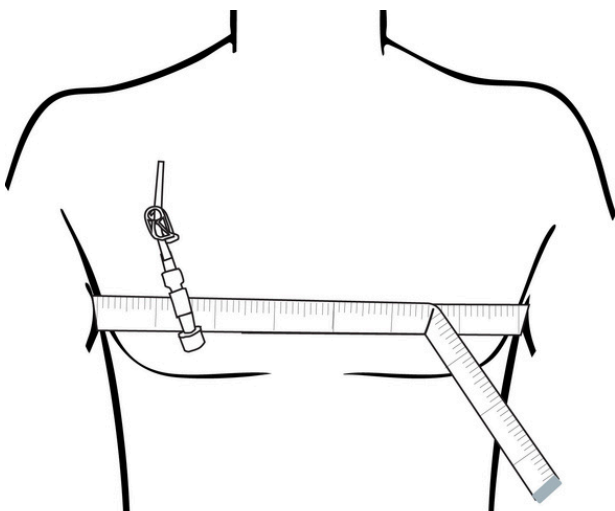

TABLE OF CONTENTS

Prepare the Vest.....	3
Put on the Vest	4
Adjust for Fit.....	7
Apply Dual Safe Strip.....	7
Placement of the Dual Safe Strip.....	8
Secure the Catheter.....	9
For Double Lumen Catheters.....	9
Close Front Flap.....	11
Secure Infusion Tubing/ Site Assessment.....	12
Removal of The Vest.....	13
LOCK 2000 Vest Care.....	15

HOW TO MEASURE

Measure around the
broadest part of the chest



LOCK 2000 Vest Sizes

Size 1	13-16.5 in	33-42 cm
Size 2	16-19.5 in	40.5-49.5 cm
Size 3	18-24 in	45.5-61 cm
Size 4	21.5-30 in	54.5-76 cm
Size 5	28-41 in	71-104 cm
Size 6	37-56 in	94-142 cm



NOTE: Instructions show a Size 4 Vest. Certain specifics may vary based on size.

1

PREPARE THE VEST

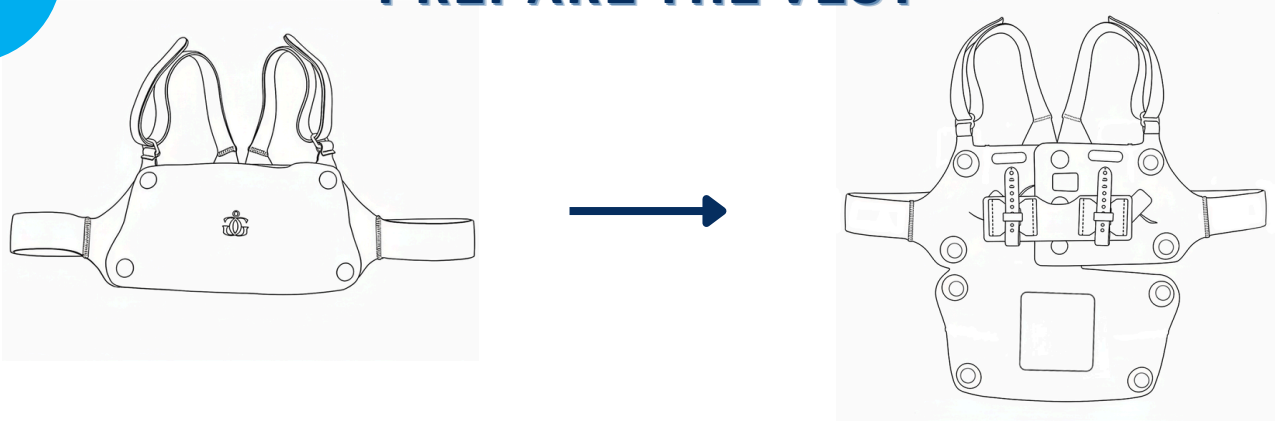

Open the front flap by disengaging the snaps and velcro.

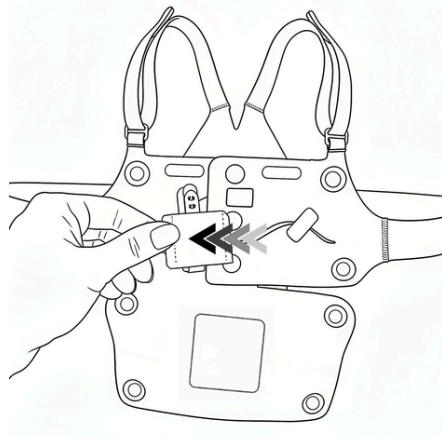

Remove the Dual Safe Strip.

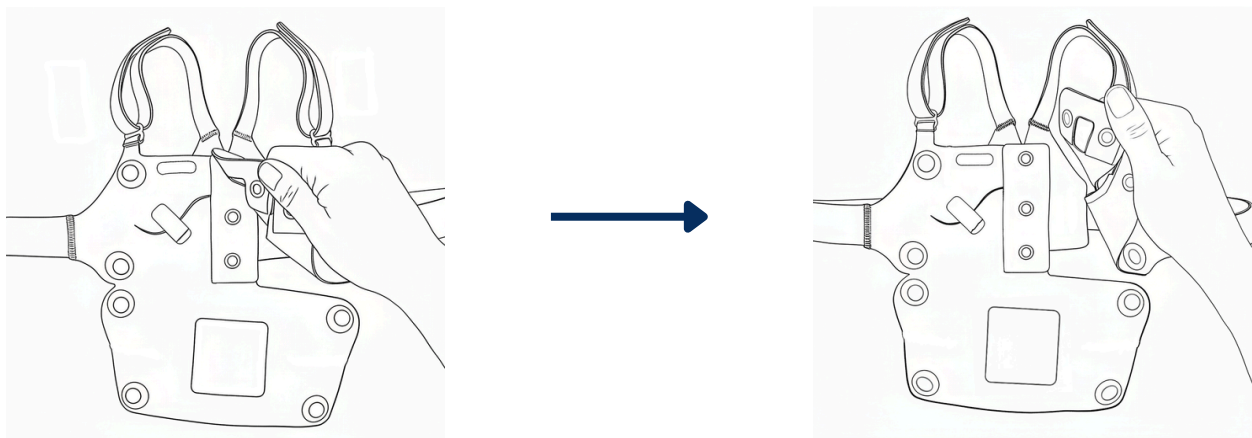

Starting at the bottom, open the vertical snap closure in the center of the LOCK 2000 Vest.

The LOCK 2000 Vest will now be fully open like a coat.



PUT ON THE VEST & INCORPORATE THE CATHETER

- **NOTE:** Slight adjustments in the angle of the dressing or exit location of the catheter from the dressing will yield very different results with the Vest.

In general, it is ideal to have the line exit the dressing toward the side of the body regardless of the exit site's placement, as shown.

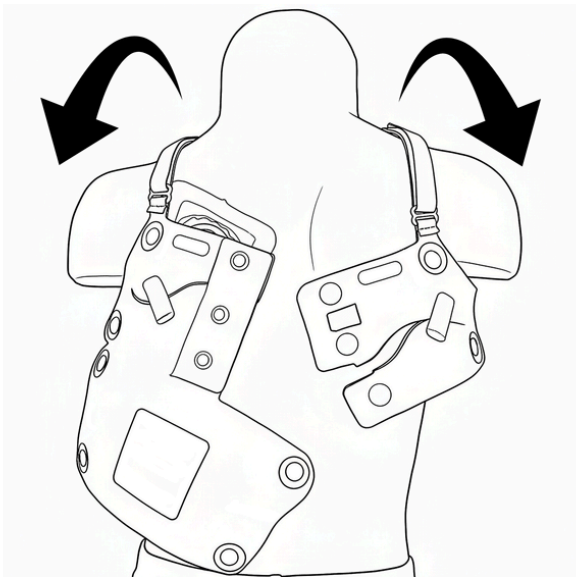

- Put on the LOCK 2000 Vest like a coat, arms through the arm holes, opening in the BACK.

2

PUT ON THE VEST & INCORPORATE THE CATHETER (CONT.)

IF NOT INFUSING

- Thread catheter through either left or right access slot, depending on the exit site's location.
- Open small velcro tab(s) on either side as needed.
- Close center vertical snaps.

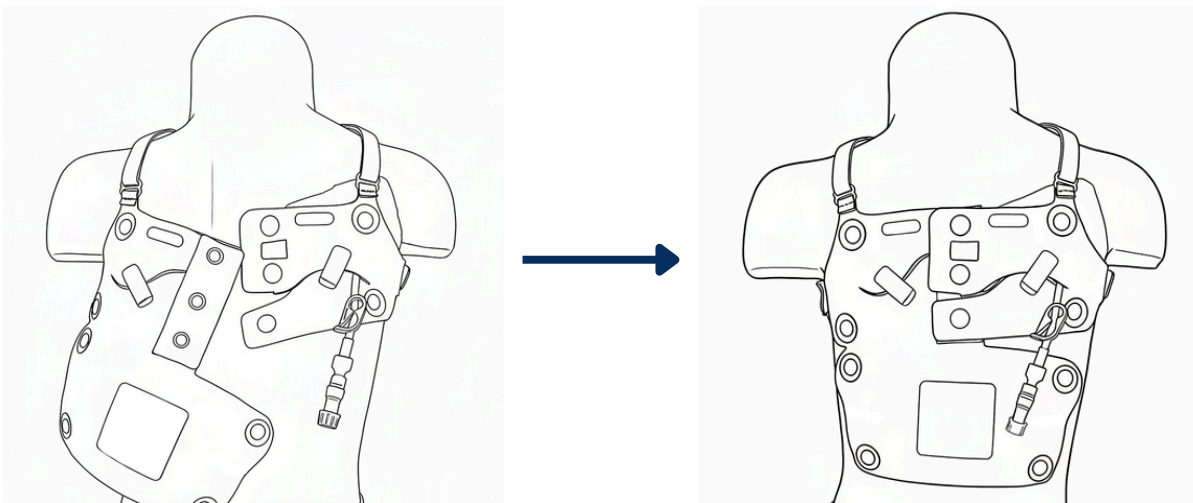
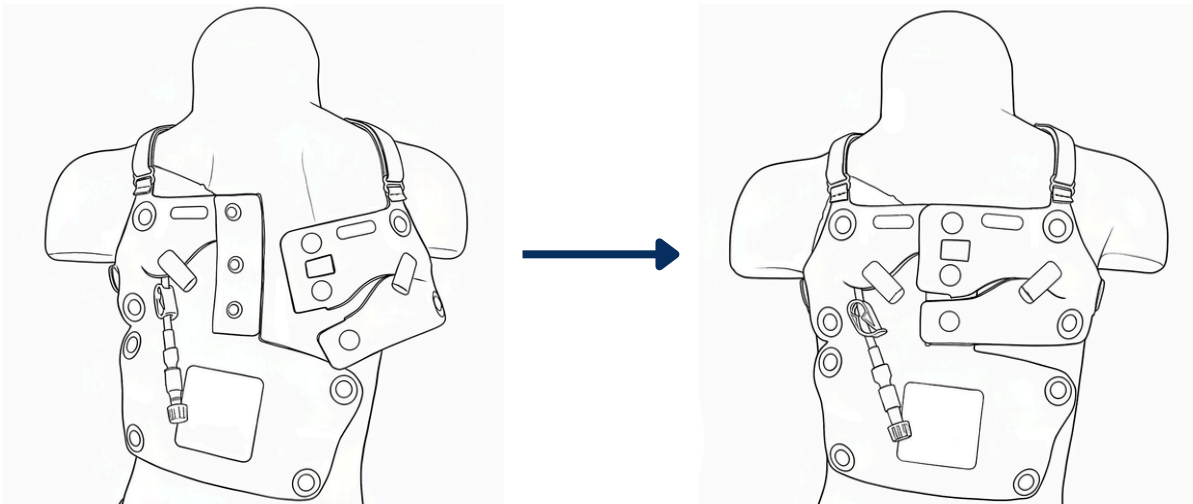

2

PUT ON THE VEST & INCORPORATE THE CATHETER (CONT.)

IF INFUSING

- If the line is on the **RIGHT**, simply pass the catheter through the access slot on the left, opening the velcro tab as needed.
- Close center vertical snaps.

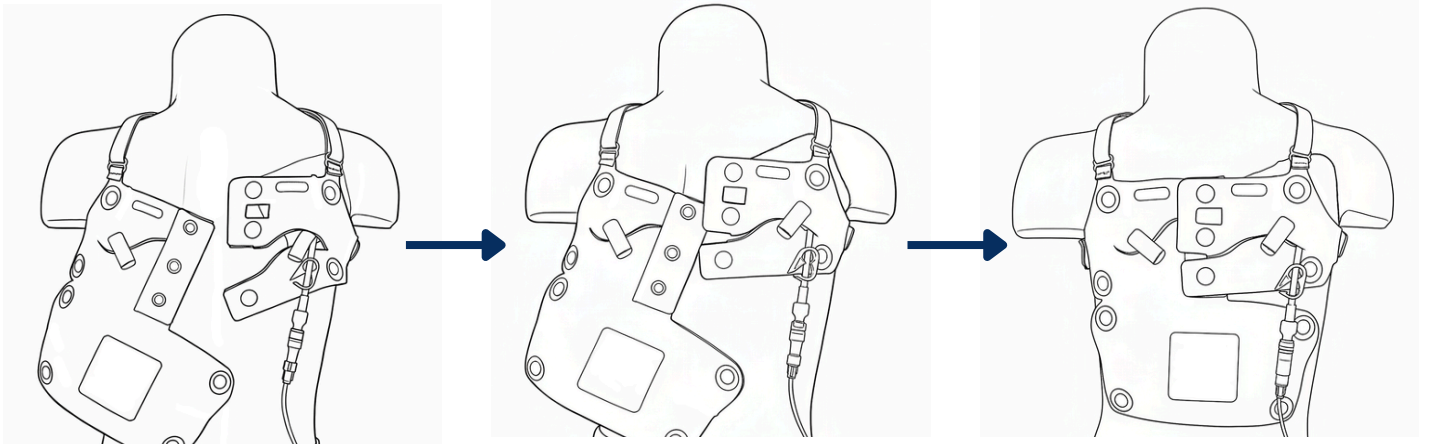

- If the line is on the **LEFT**, disengage/separate the velcro on the back of the top green snap.
- Pass the catheter through the slot, opening the velcro tab as needed.
- Refasten the velcro after the catheter is through the access slot, including velcro behind top snap.
- Close center vertical snaps.

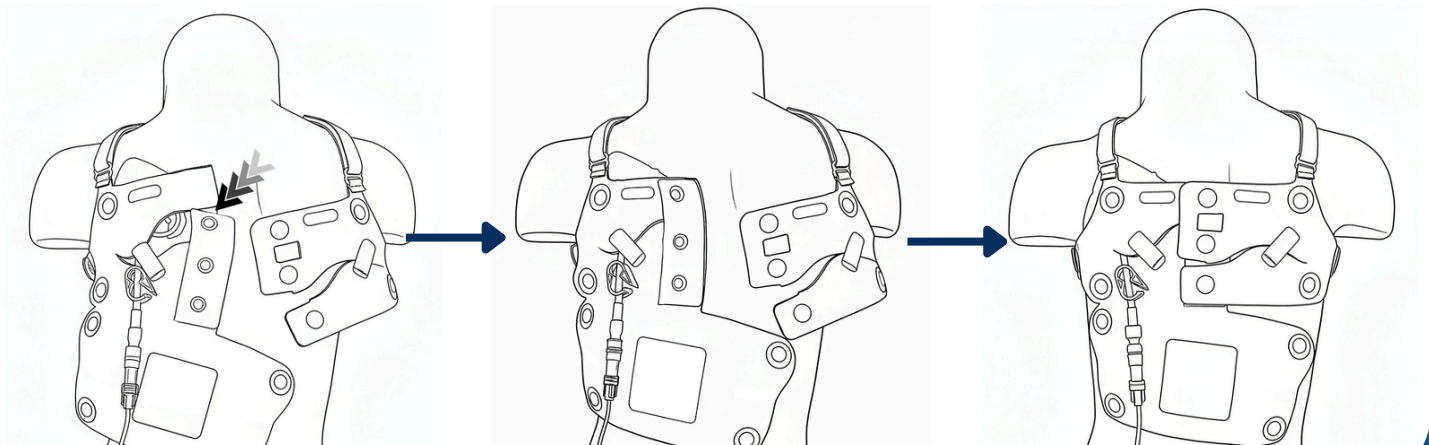

3

ADJUST FOR FIT

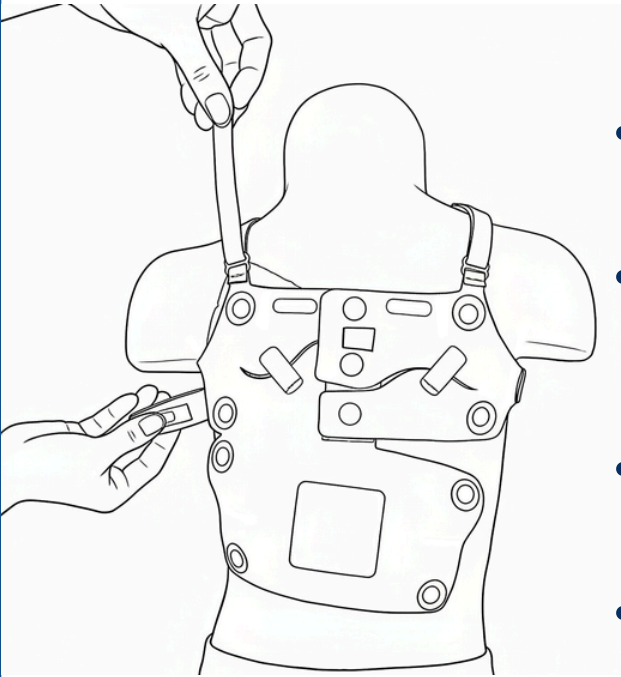

- Adjust torso and shoulder straps **EVENLY** on either side for a good fit.
- **The Vest should be snug** and should not move around on the body.
- Use the shoulder straps to adjust the location of the Vest (high or low) on the back, suitable to the line placement.
- Straps on the shoulders and torso should be **snug**.
- **PLEASE NOTE:** Fabric may "ease" and loosen as it is worn. Periodically check for snugness and **adjust as needed**.

4

APPLY DUAL SAFE STRIP

- Affix Dual Safe Strip to inside of the LOCK 2000 Vest.
- **Press firmly** to fully engage velcro throughout Dual Safe Strip.
- Dual Safe Strip must be **fully adhered** to the LOCK 2000 Vest to prevent catheter damage.
- Dual Safe Strip can be located in any configuration that offers full engagement with the Vest.

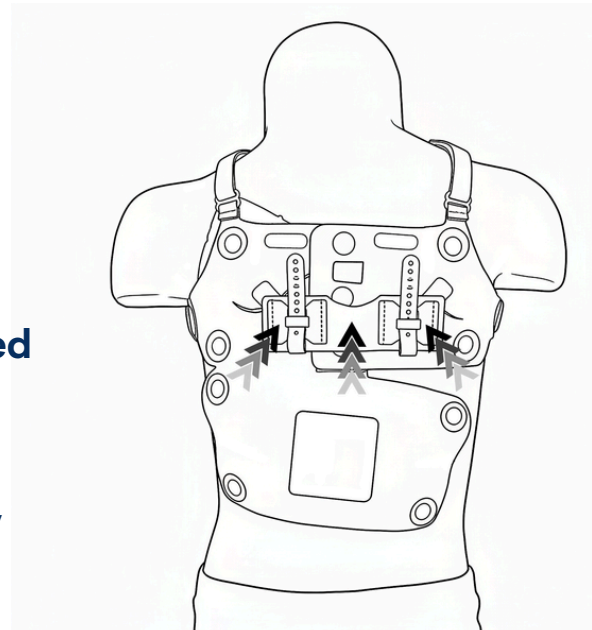

PLACEMENT OF THE DUAL SAFE STRIP

- Dual Safe Strip can be centered, off-center, or diagonal, depending on the most suitable placement for your exit site.
- Ensure Dual Safe Strip's placement over snaps does not impair its adhesion to fabric (ie. do not place the end of the Dual Safe Strip on a snap.)

DO



DON'T



SECURE THE CATHETER

FOR ALL CATHETERS

- Attach infusion tubing to catheter as needed.
- Secure catheter using securement strap on Dual Safe Strip that is closest to the exit site.
- Secure infusion tubing with second securement strap.
- Snug securement strap down to tubing.
- Cap/clave/connection point should be **BETWEEN** the two securement straps.

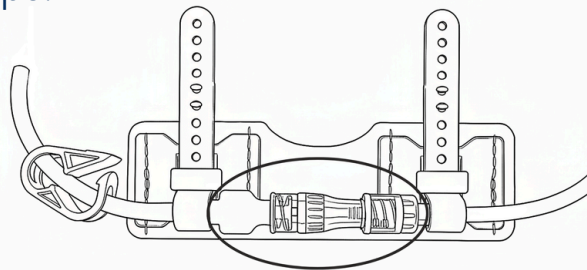

FOR DOUBLE LUMEN CATHETERS

OPTION 1 - ALL VEST SIZES

Secure both lumens together using 1 securement strap for catheters and 1 strap for tubings.

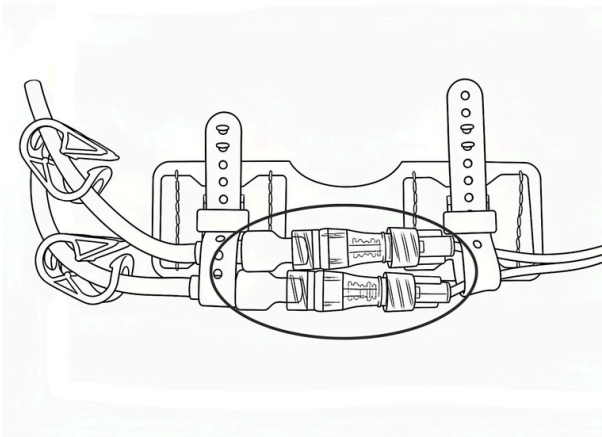

OPTION 2 - SIZE 5 & UP

Separate lumens using 2 additional Single Safe Strips to secure the second lumen.

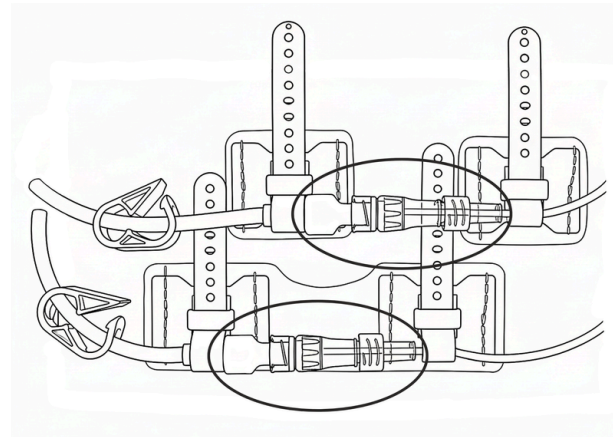

SECURE THE CATHETER (CONT.)

- Securement strap should be snug, but not too tight.
- **WARNING:** **Over-tightening** securement strap **will lead to breakage!**
- To secure strap, place finger over and under tab as shown.
- Pinch strap to secure on both posts.

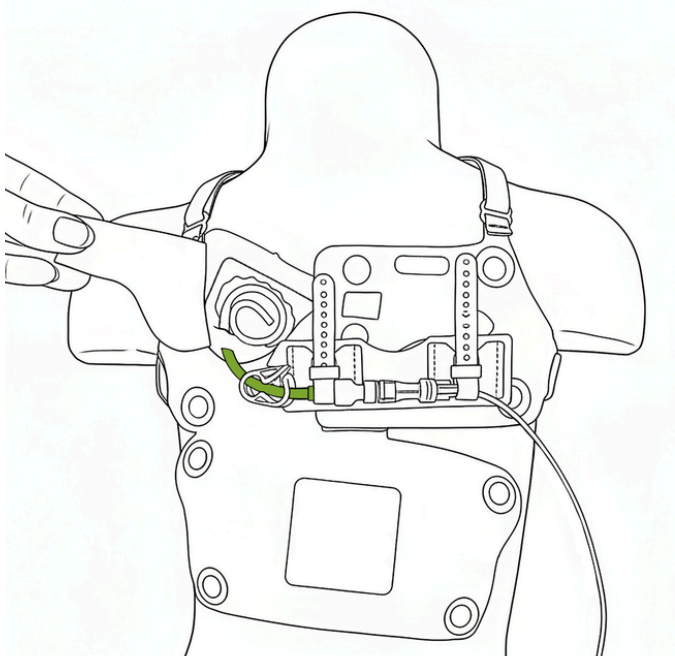
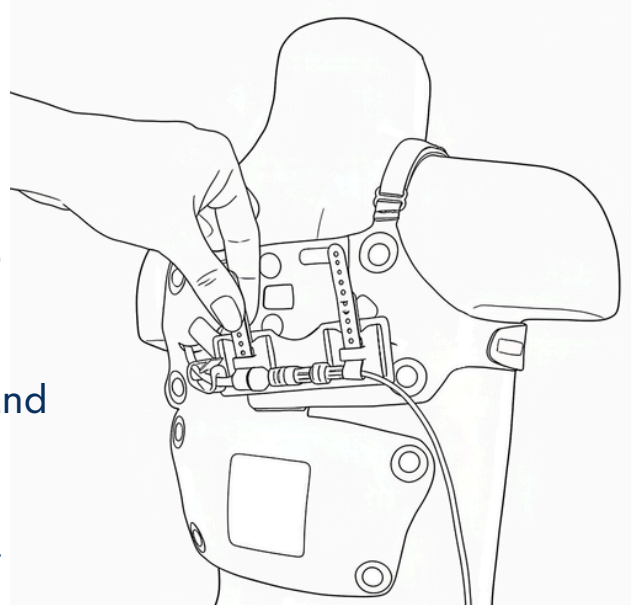

- **NOTE:** For optimal performance, **allow slack** in the catheter between the edge of the dressing and the first securement point on the Dual Safe Strip.
- An example is shown.

- If Dual Safe Strip is not in an ideal location, it can be carefully moved:
 - **WARNING! DETACH** catheter and infusion tubing from securement straps **before moving!**
- Reattach in a more suitable location and repeat Step 4.

6

CHECK SET-UP FOR SAFETY

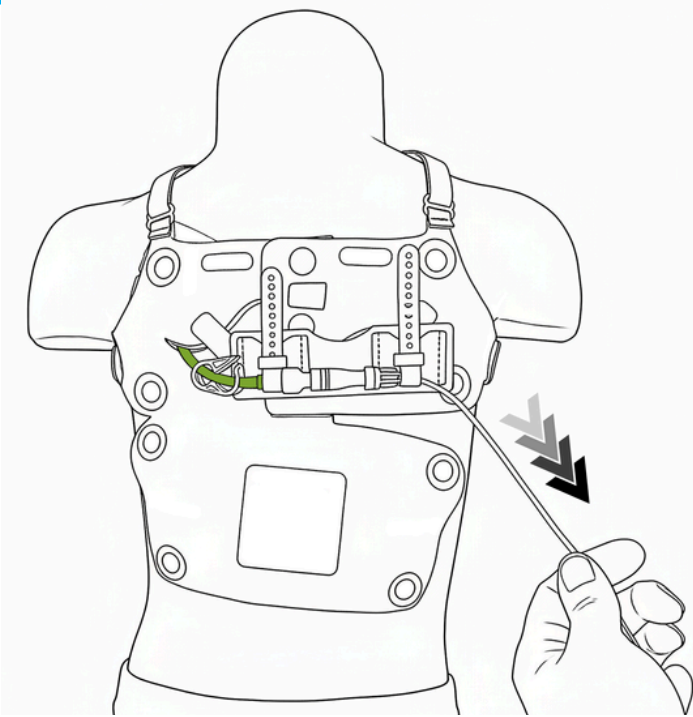

- **GENTLY** pull infusion tubing, as shown.
- Dual Safe Strip should remain fully adhered to LOCK 2000 Vest.
- There should be **NO STRESS** on central catheter.
- Adjust as needed to achieve this.

7

CLOSE FRONT FLAP

- Close front flap by closing snaps around the perimeter of the flap.
- Tubing can be routed between any of the snaps along the sides or top of the Vest.
- **DO NOT** route tubing through the larger opening at the bottom of the Vest.
- **CAUTION:** Ensure central line and tubing are away from snaps before applying pressure to them.
- Place finger behind the LOCK 2000 Vest to close each snap as shown.



8

SECURE INFUSION TUBING (IF INFUSING)

- Bring the infusion tubing to the back of the Vest.
- Use the Single Safe Strip to add a **3rd point of securement** and remove the infusion tubing from immediate access.
- **CAUTION:** Do not lie on or apply prolonged pressure to the Single Safe Strip (e.g., during sleep), as this may cause skin injury.

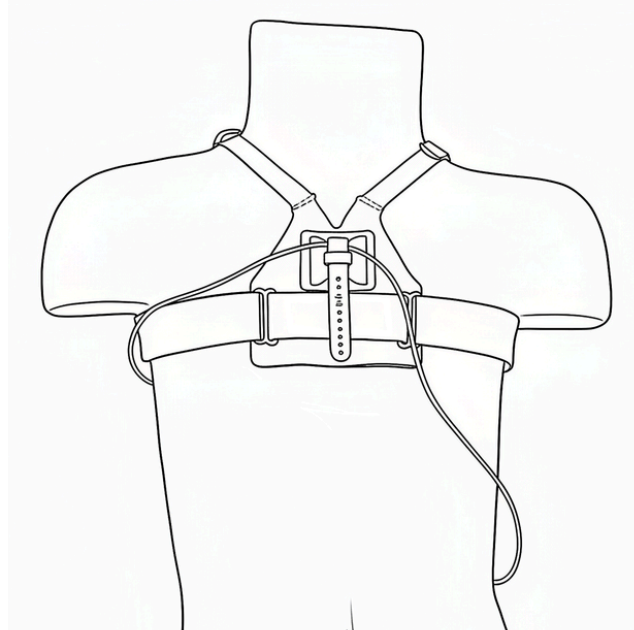

9

SITE ASSESSMENT

To assess the exit site, choose one option:



1. Open one shoulder strap and pull down the top of LOCK 2000 Vest to view the exit site.

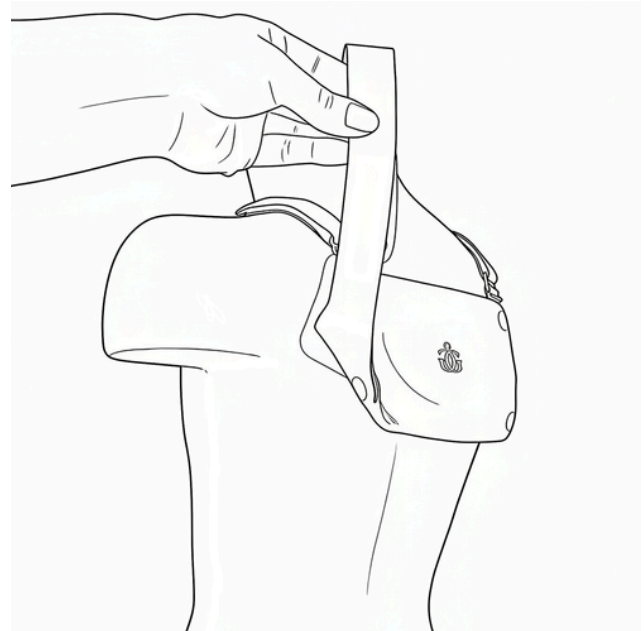

2. Open one torso strap and lift the side of LOCK 2000 Vest to view the exit site.

REMOVE THE VEST WITHOUT STOPPING AN INFUSION

- **Use 2 hands** to separate the snaps: one to stabilize the back of the snap and one to separate the front, disengaging the front flap.
- Avoid pulling the Vest away from the body.

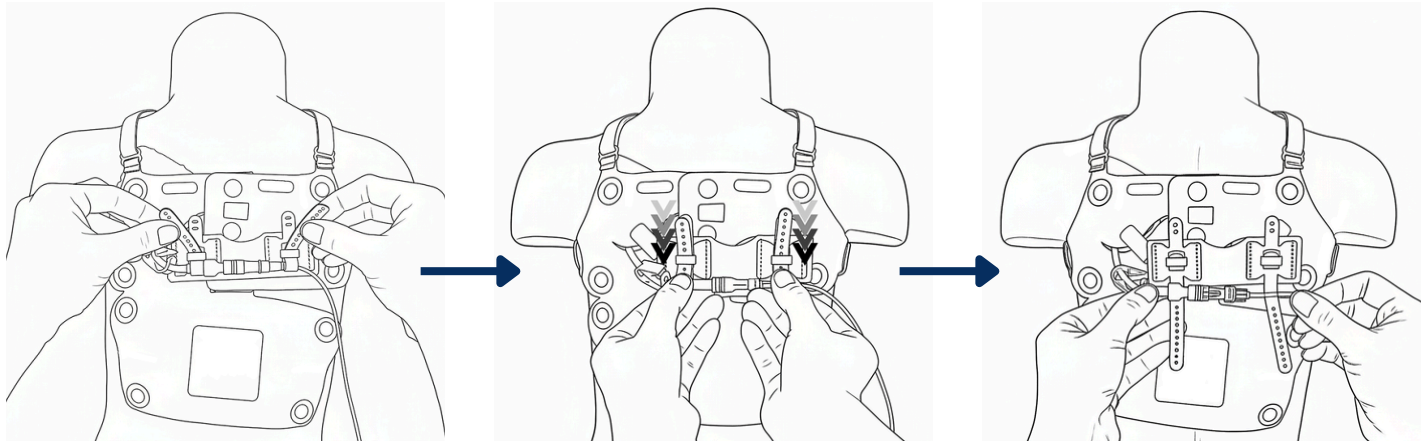
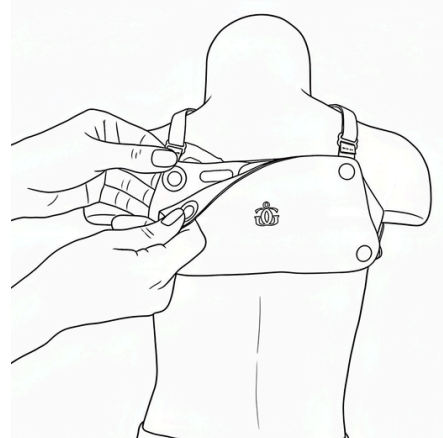

Detach catheter and infusion tubing from Dual Safe Strip.

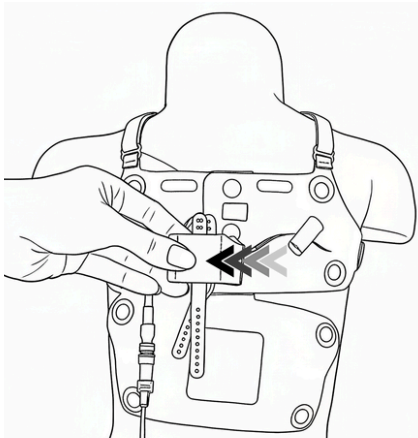

Partially or completely
remove the Dual Safe Strip.

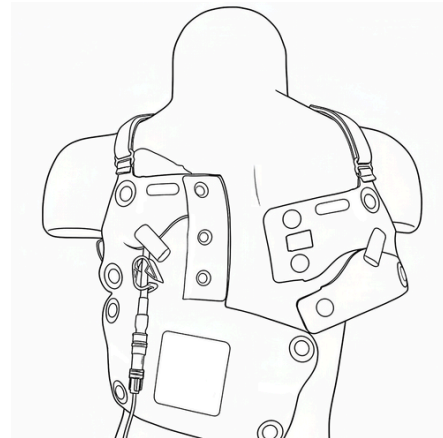

Unsnap the vertical
center snaps.

REMOVE THE VEST WITHOUT STOPPING AN INFUSION (CONT.)

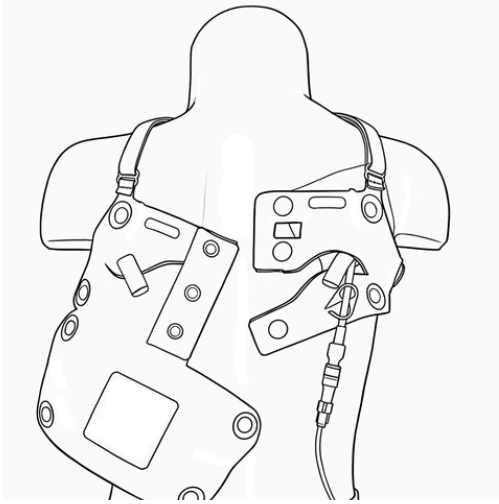

If the line is on the **RIGHT**:

- Pass the catheter through the slot, opening the velcro tab as needed.

If the line is on the **LEFT**:

- Disengage/separate the velcro on the back of the top green snap.
- Pass the catheter through the slot, opening the velcro tab as needed.

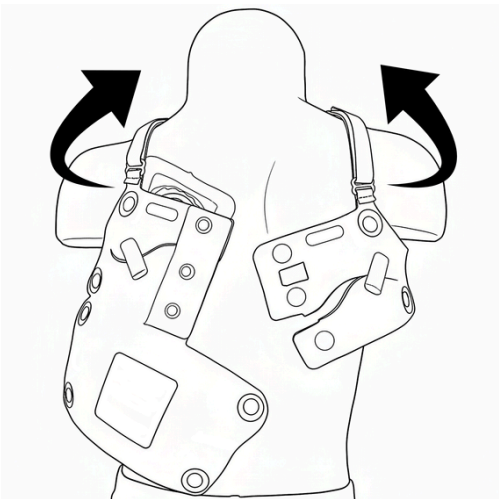
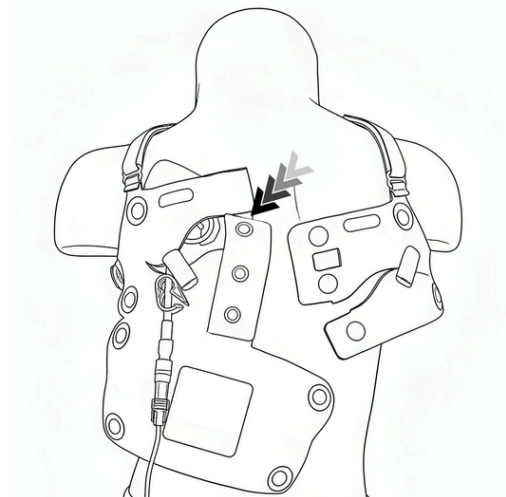

FOR ALL Exit sites:

- Remove LOCK 2000 Vest, being careful of the central catheter.
- Replace with a clean LOCK 2000 Vest and start over at STEP 2.

LOCK 2000 VEST CARE

- Clean the Vest no less than once a week **AND** when soiled.
- Before washing, close the front flap and engage all velcro, including the Single Safe Strip and Dual Safe Strip.
- Machine wash. Gentle cycle, cold water. Hang dry only (no dryer).
- For more detailed care instructions, [CLICK HERE](#).

Looking for FAQs? [CLICK HERE](#).

Instructional Videos [CLICK HERE](#).

JOIN US ON SOCIAL MEDIA

Get connected for our latest news and updates



Gus Gear's streamlined LOCK 2000 Vest is designed to maximize comfort and ease of use — while still providing the same trusted securement.

To learn more about how the LOCK 2000 Vest compares to our previous Central Line Vest, [CLICK HERE](#).

CONTACT US

For product support, our team is always here to help

